

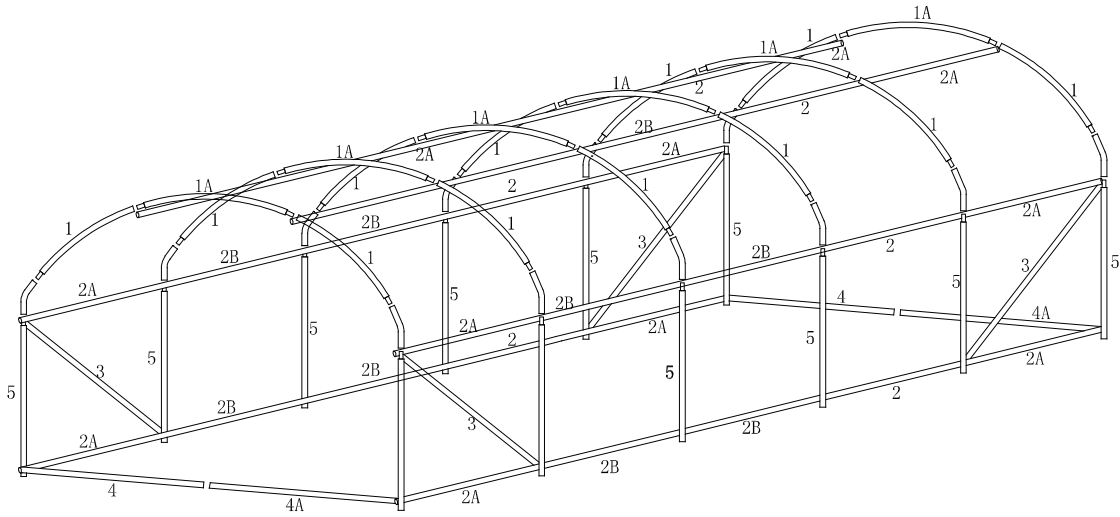











3x8x2

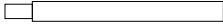

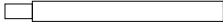
1#		12
1A#		6
2#		6
2A#		12
2B#		12
3#		4
4#		2
4A#		2
5#		12
		12
	 M6*55	32
	 M6*55	4
	 M6	2