

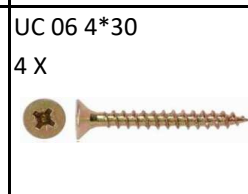

A/80/2A

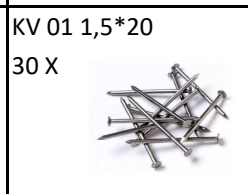

1.

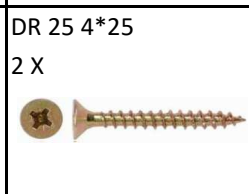
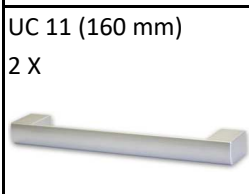
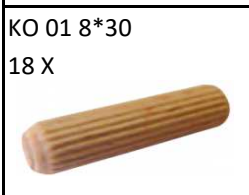
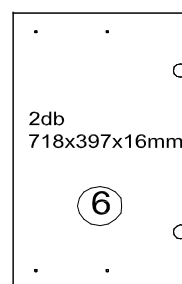
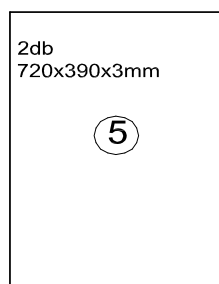
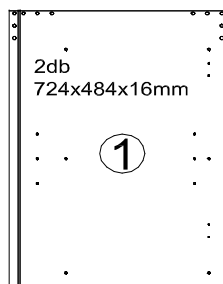
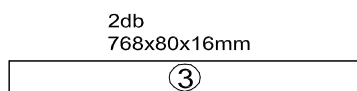
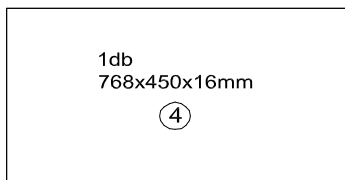
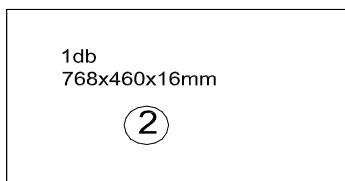
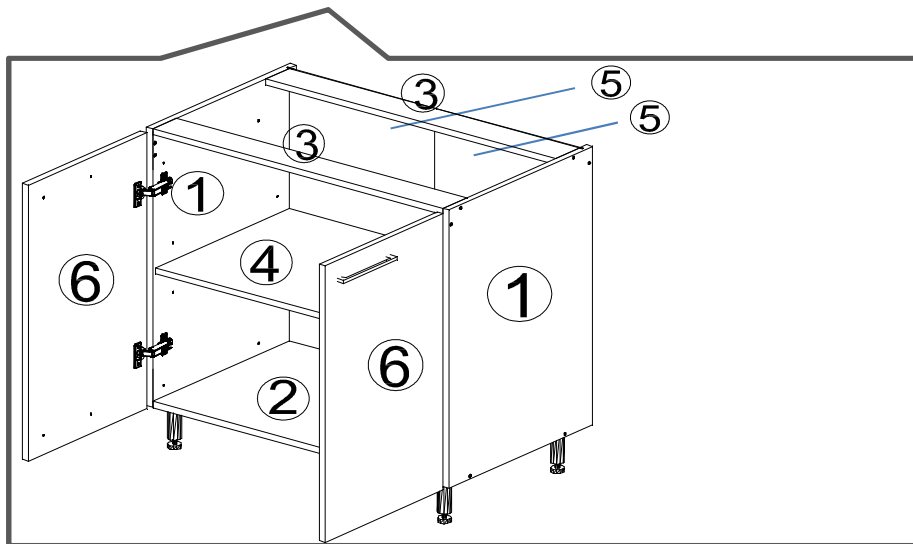
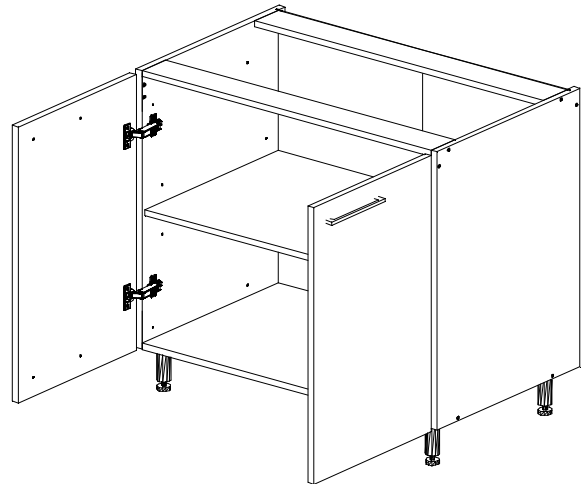
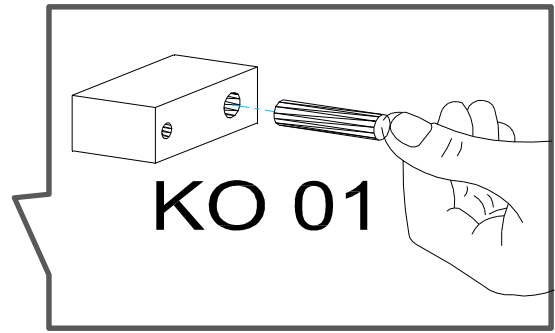
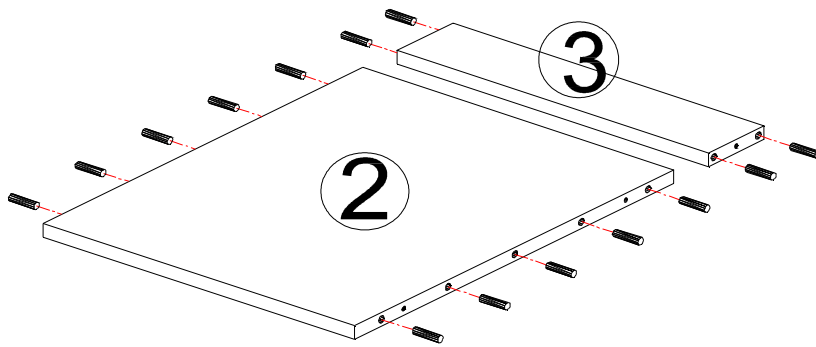

2.

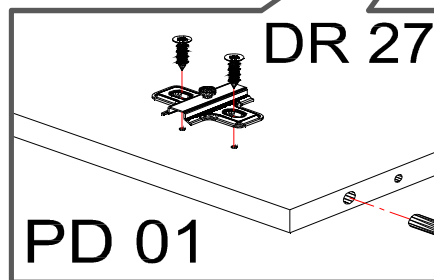
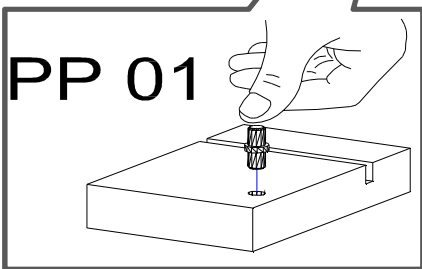
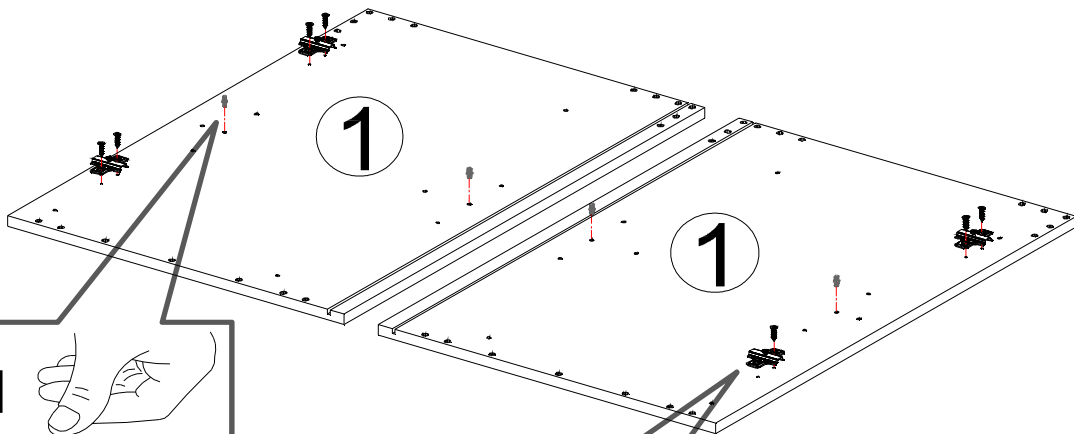

3.

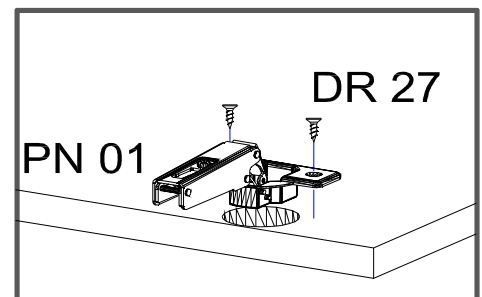
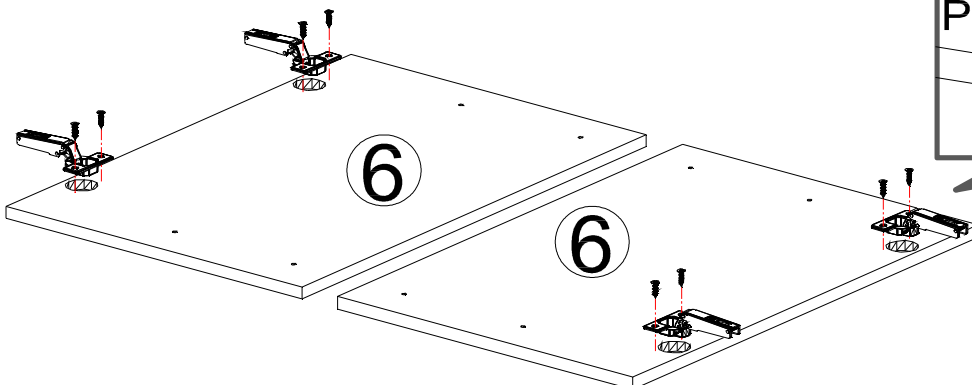

4.

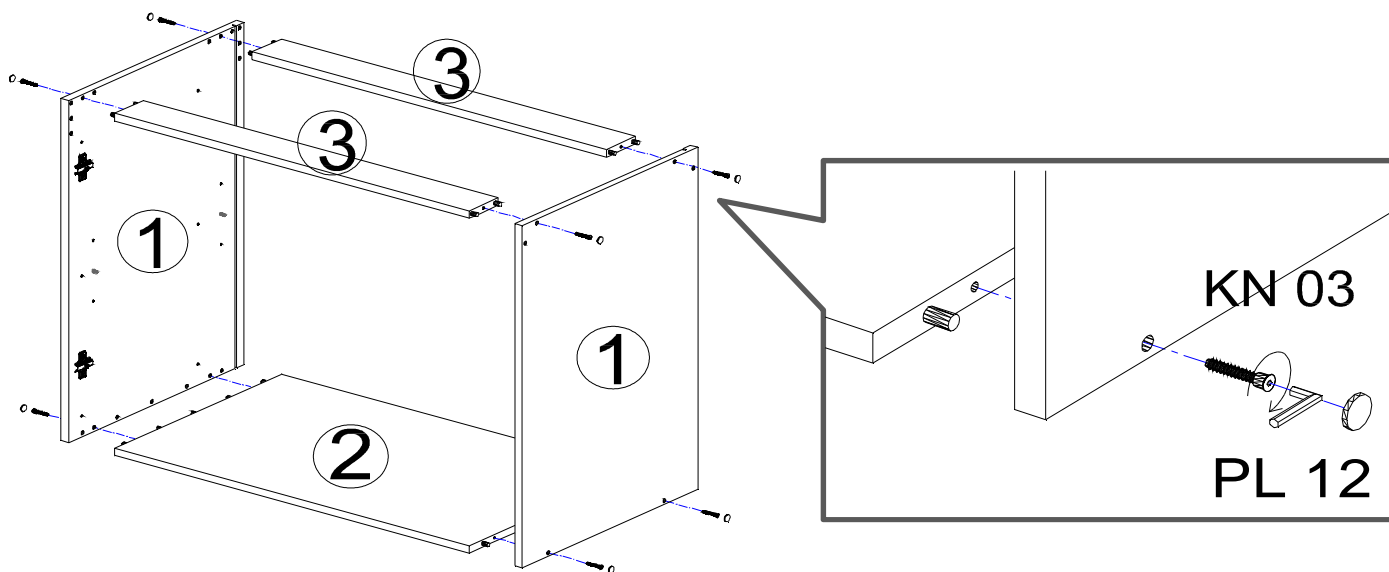

5.

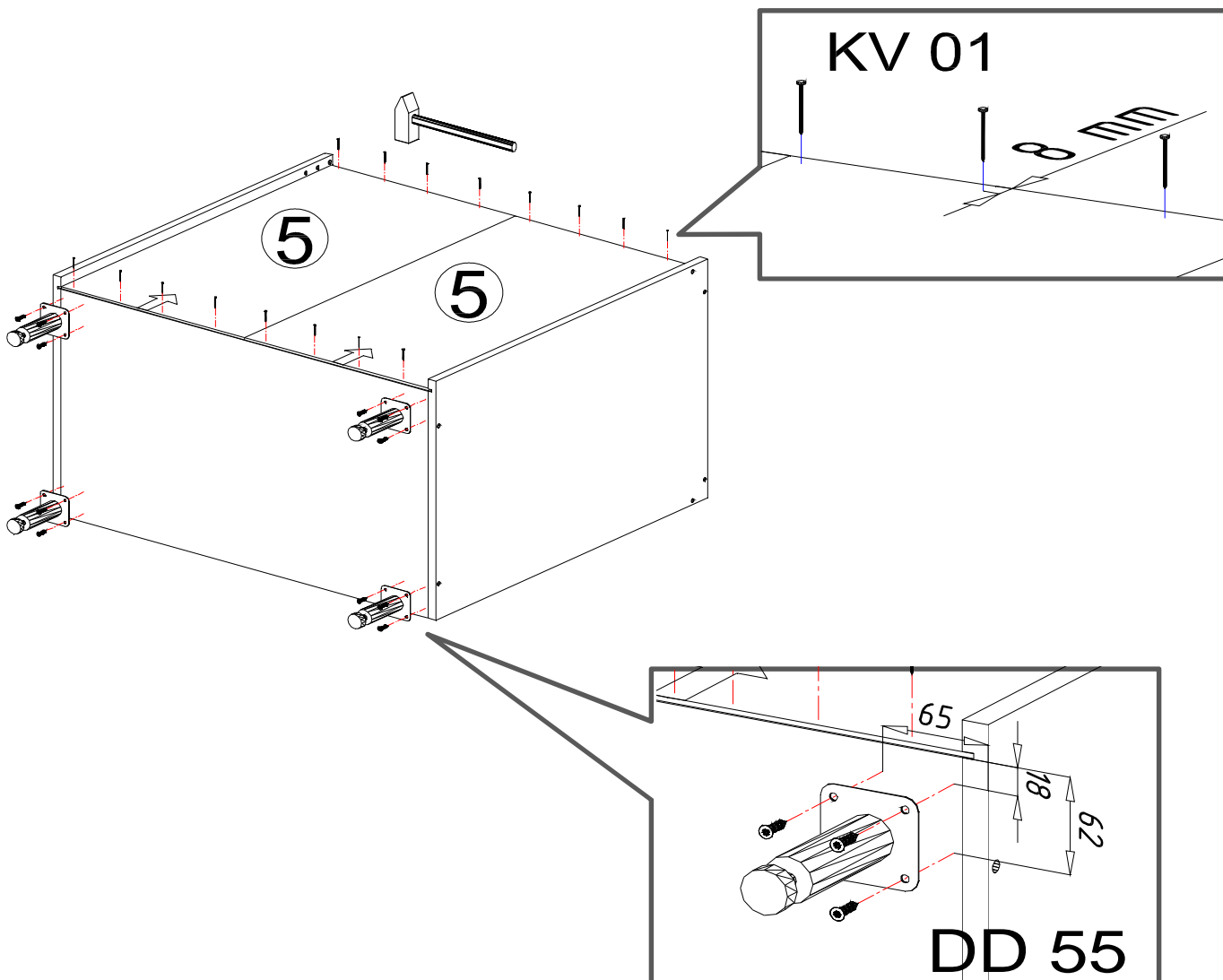

6.

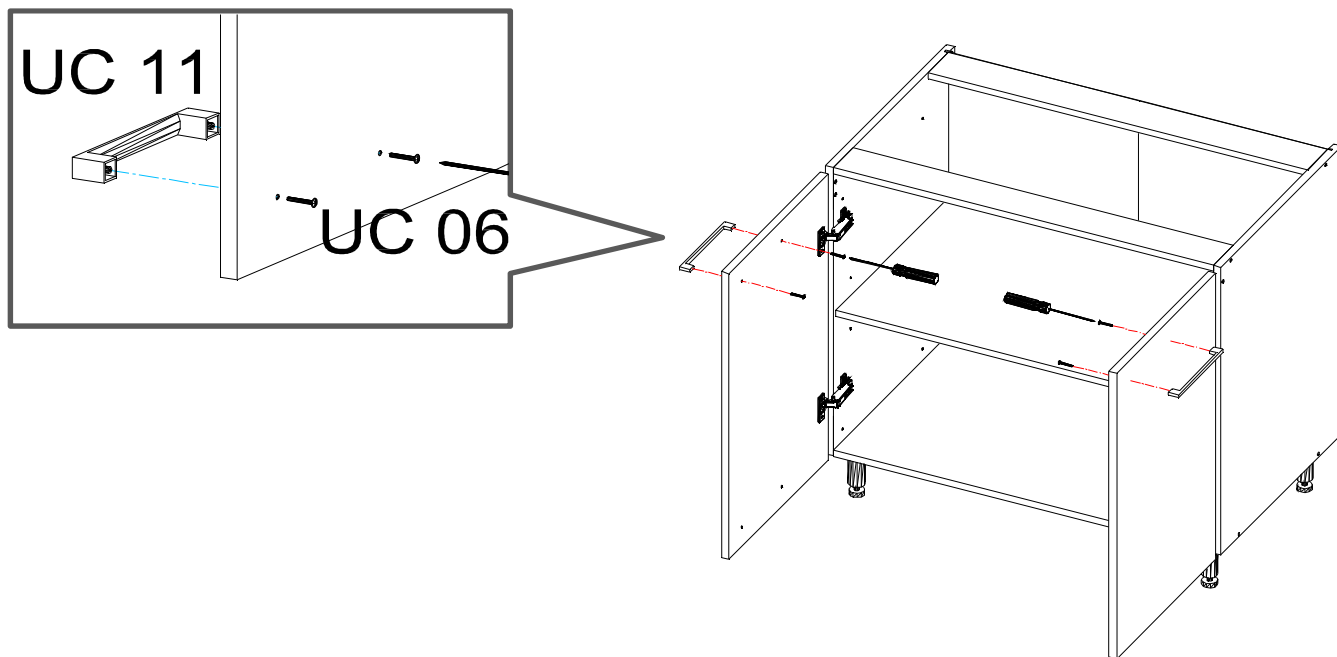

Az elemek megfelelő stabilitása és baleset megelőzés céljából, az elemeket célszerű egymáshoz rögzíteni egy rejtett pozícióban a (DR 25 4*25) facsavarral!

