

## **INSECTSYSTEM BASIC**

70986, 70987, 70988, 70989

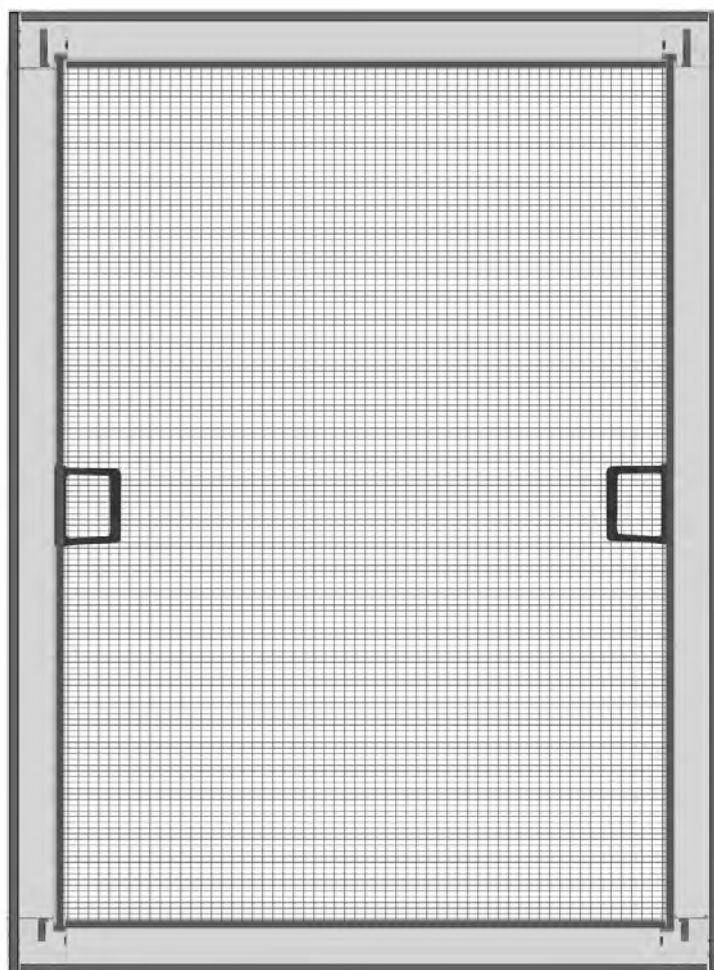

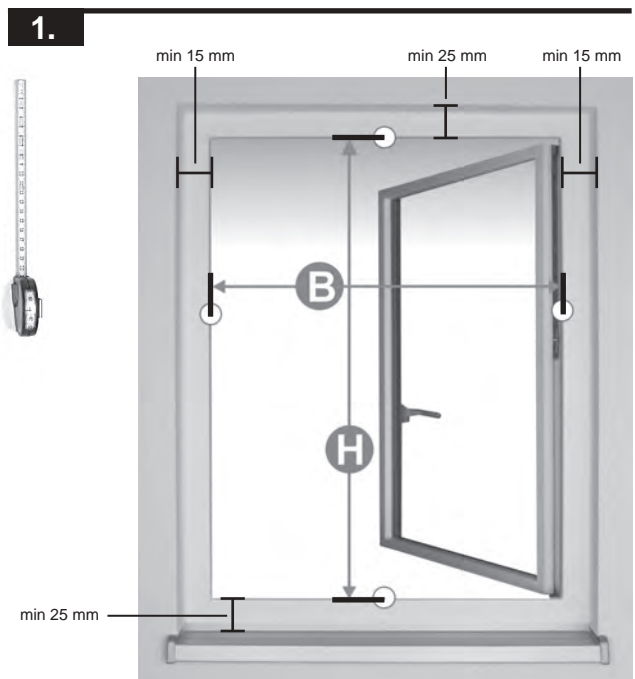
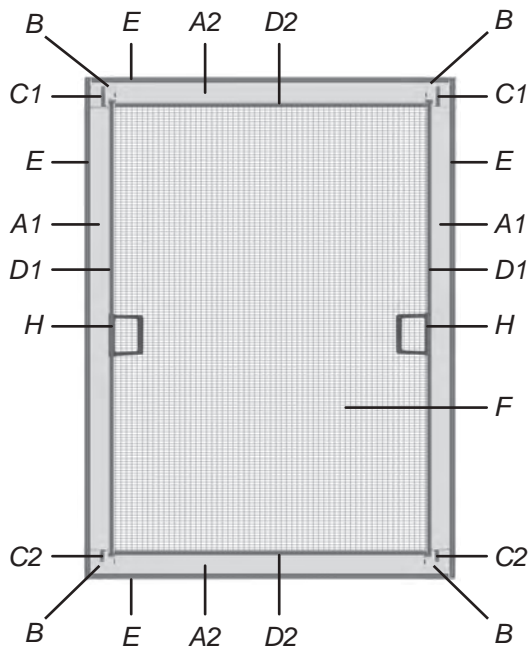
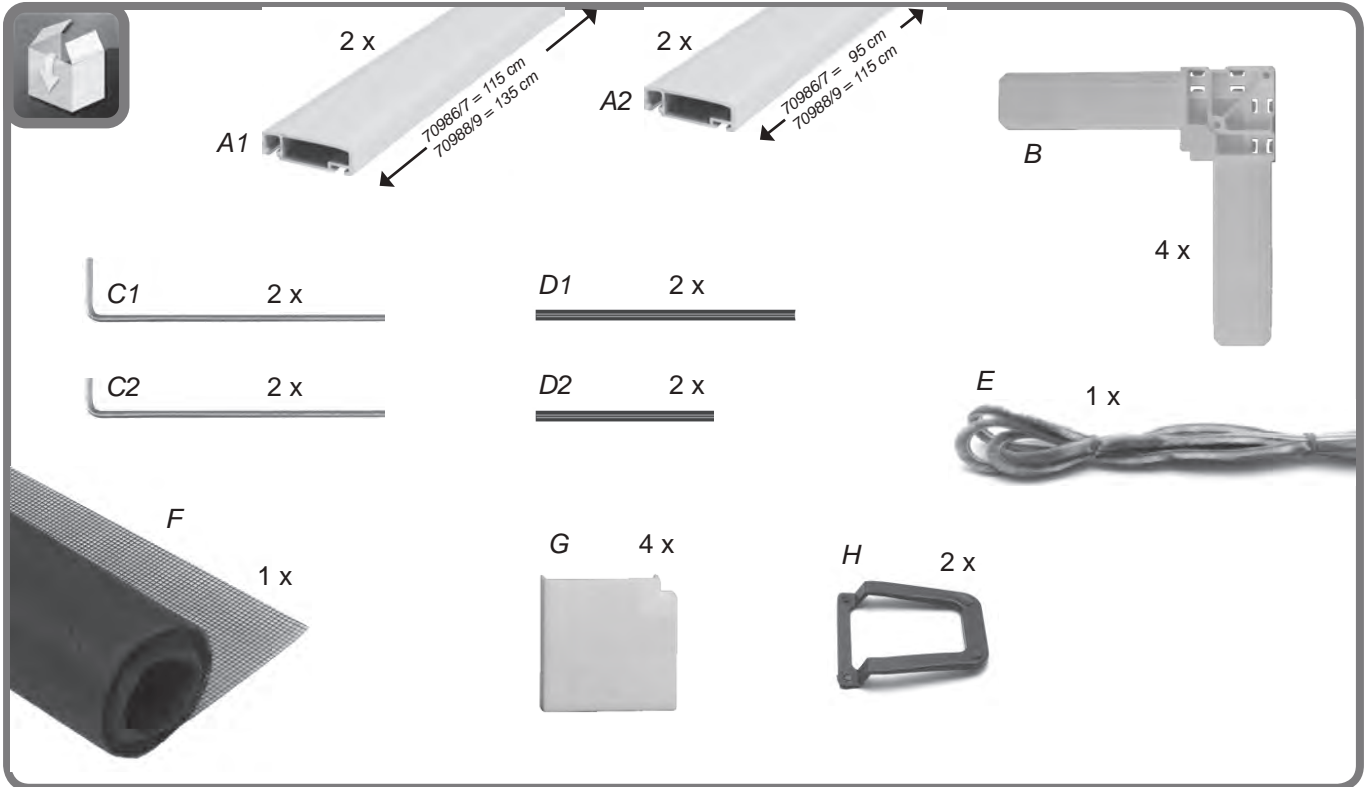

2.

**B**

70986 / 70987

= 98 cm → B - 0 mm → A2  
≤ 97 cm → B - 30 mm → A2



70988 / 70989

= 118 cm → B - 0 mm → A2  
≤ 117 cm → B - 30 mm → A2

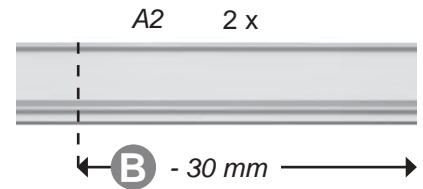

**H**

70986 / 70987

= 116 cm → H - 0 mm → A1  
≤ 115 cm → H - 10 mm → A1



70988 / 70989

= 136 cm → H - 0 mm → A1  
≤ 135 cm → H - 10 mm → A1

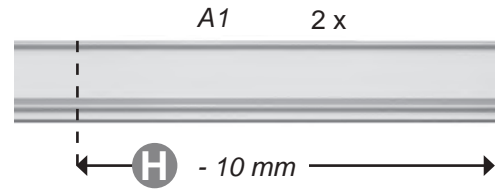

3.

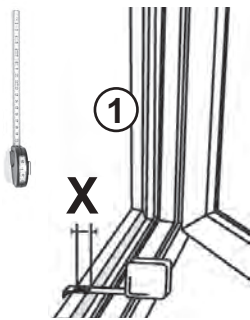

2 x C1  
2 x C2

X + 2mm

90°

2



4.

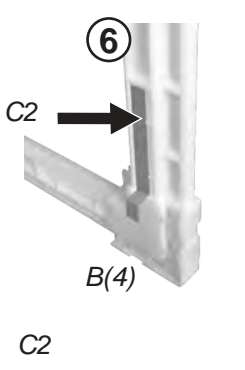
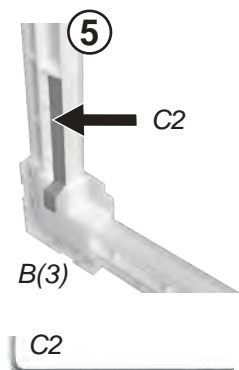
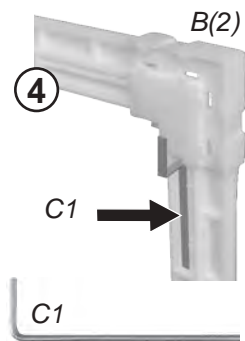
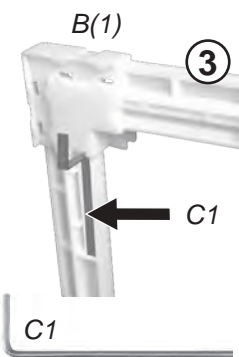

4.

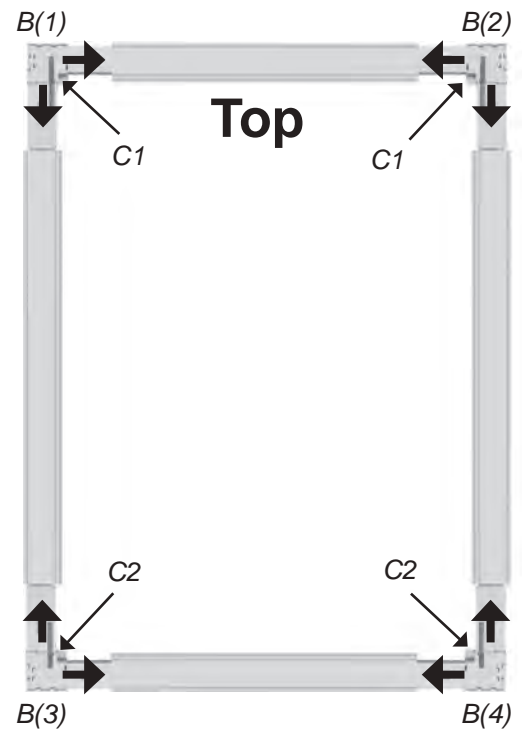

5.

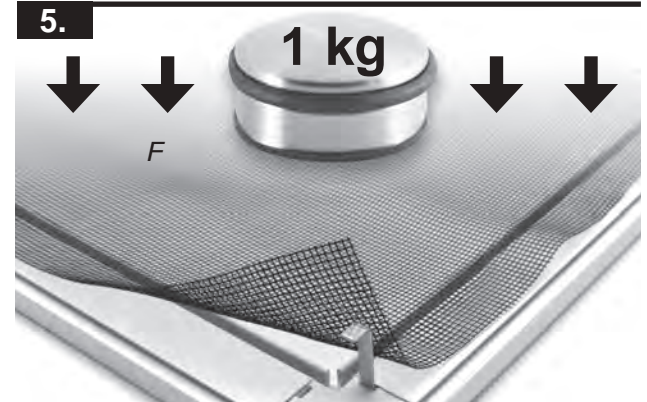

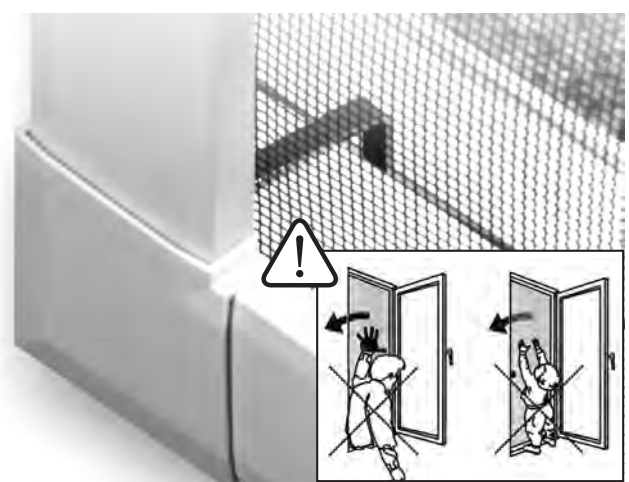
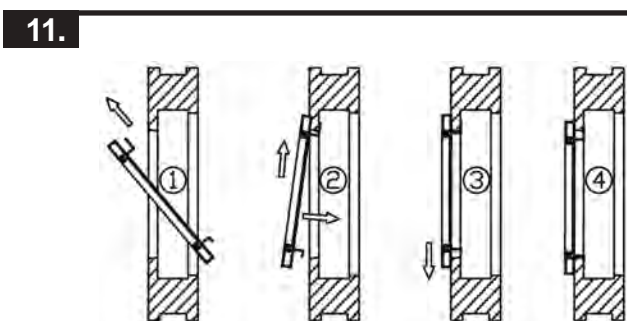
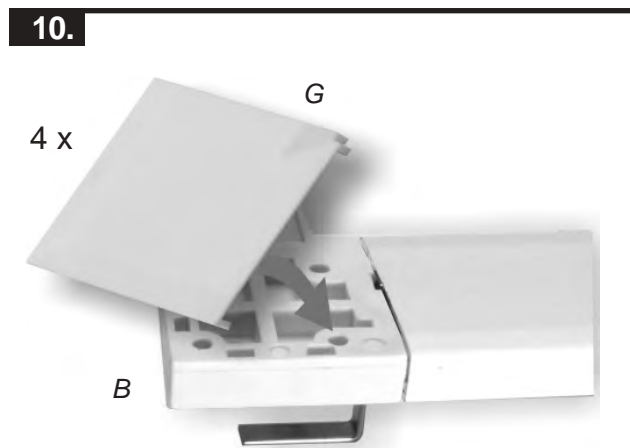
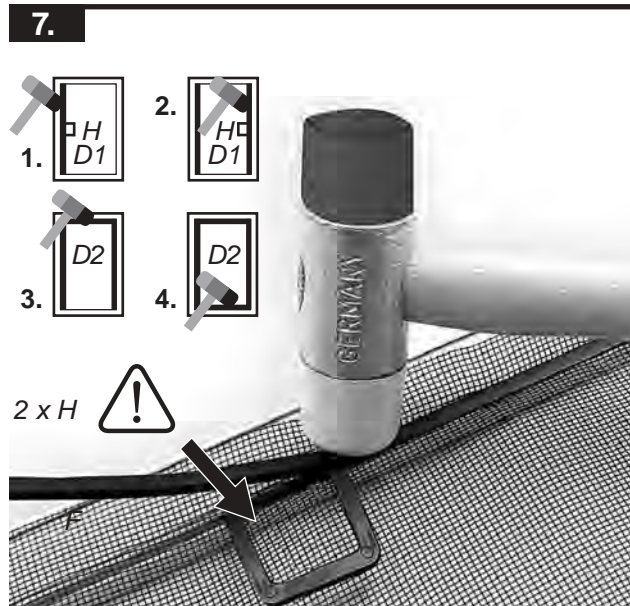
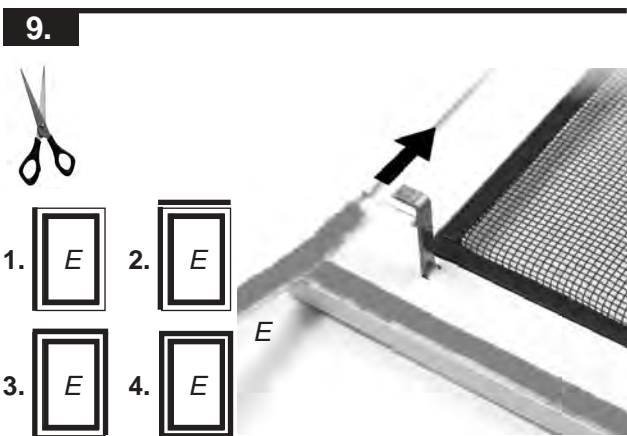
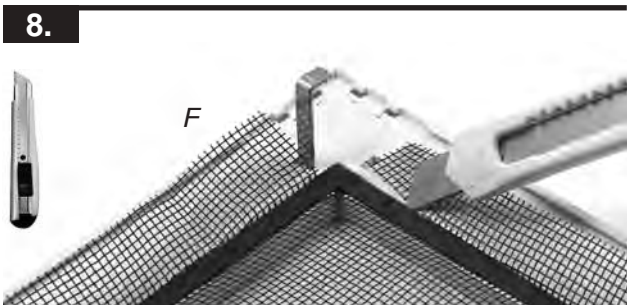

Mo-Fr: 7.30 Uhr–21.00 Uhr  
 Sa: 8.00 Uhr–14.00 Uhr  
 Tel. +49 (0)271 89056-444  
 Fax +49 (0)271 89056-398

**Alfred Schellenberg GmbH**  
 An den Weiden 31  
 D-57078 Siegen  
 service.int@schellenberg.de  
 www.schellenberg.de



MA086 / 04.20  
 Subject to literal and print error as well as technical changes.