

DECOWALL FALPANEL HASZNÁLATI ÚTMUTATÓ

Mielőtt elkezdené:

- Mérje meg a burkolni kívánt falat.
- Határozza meg, hány Decowall Acoustic panelre van szüksége.
Egy panel elegendő egy 30 x 260 cm-es fal befejezéséhez.
A paneleket 2 darabonként csomagoljuk.

You CanDo® it

SZÜKSÉGES ESZKÖZÖK



You CanDo® it

Alkalmazások Decowall Acoustic:

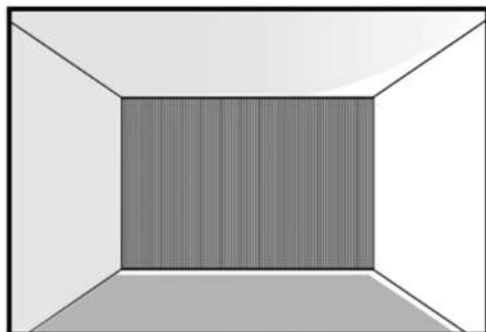

A FALON - FÜGGŐLEGESEN

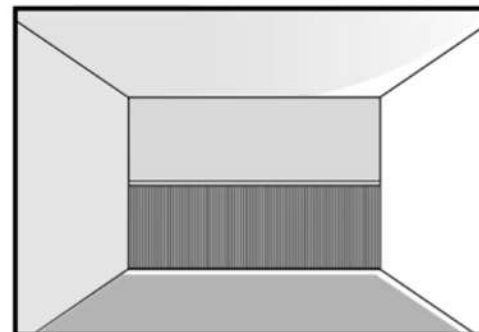

A FALON - BURKOLAT

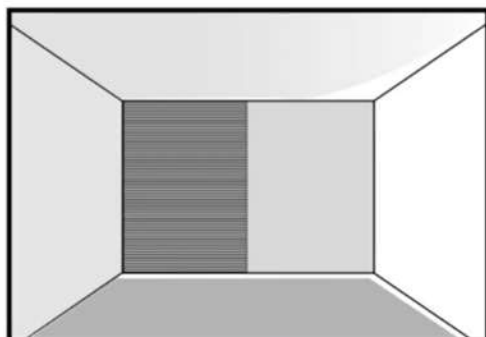

A FALON - VÍZSZINTES

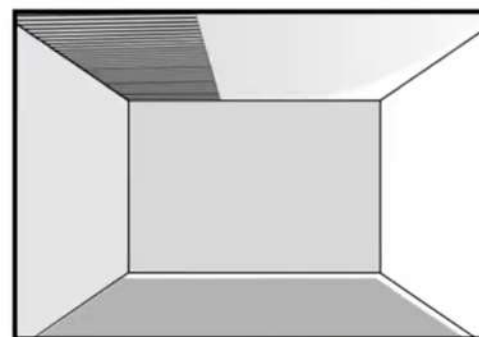

A MENNYEZETEN

You CanDo® it

A fal és/vagy a mennyezet mérése

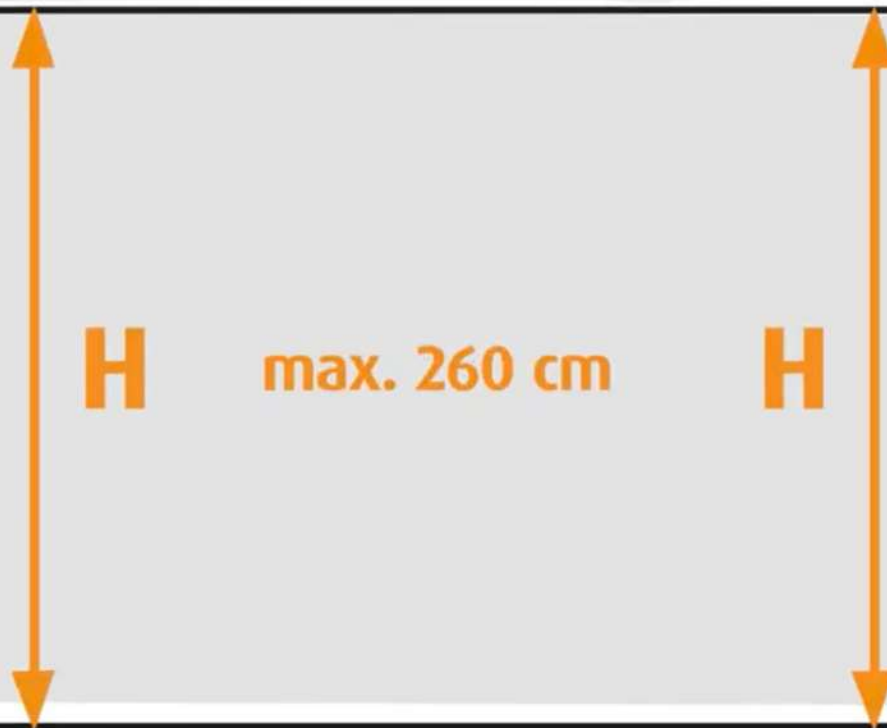

You CanDo® it

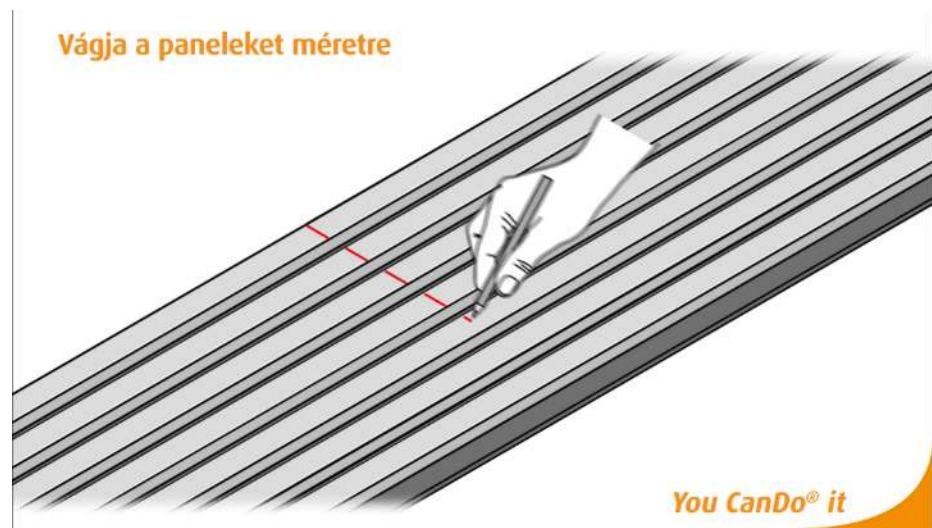
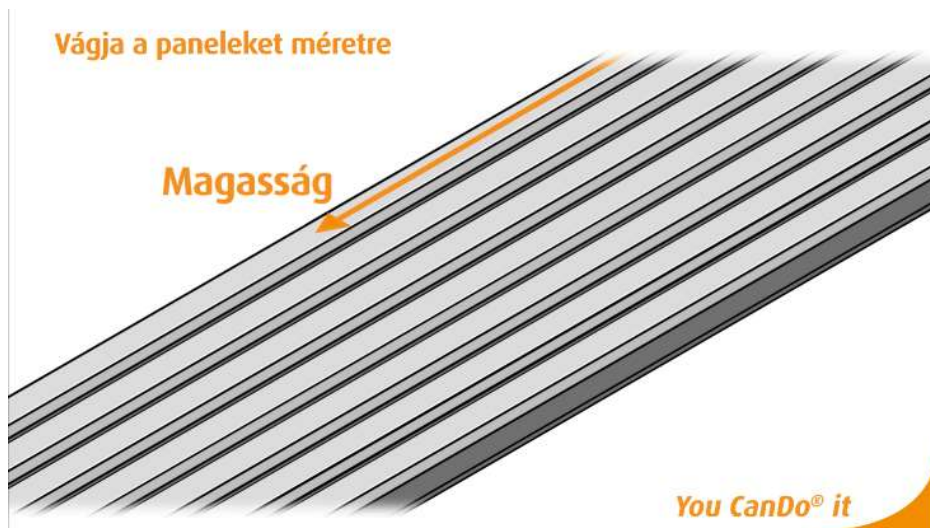

Vágja a paneleket szélességre

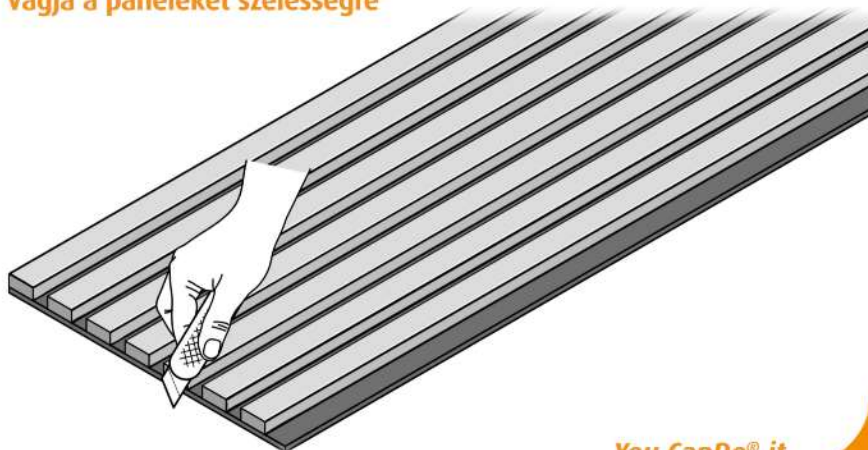

You CanDo® it

Vágja a paneleket szélességre



You CanDo® it

Vágja a paneleket szélességre



You CanDo® it

Alkalmazza a szerelőkészletet

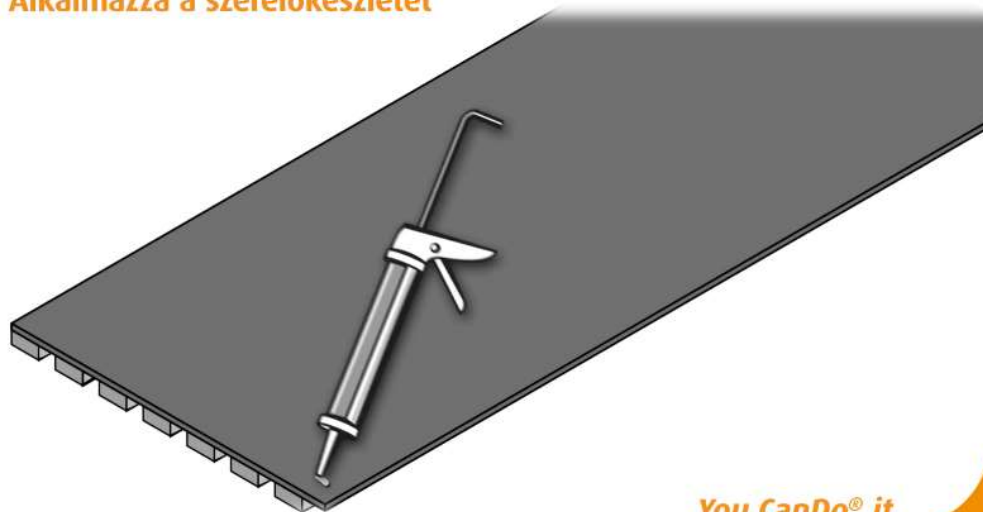

You CanDo® it

Alkalmazza a szerelőkészletet

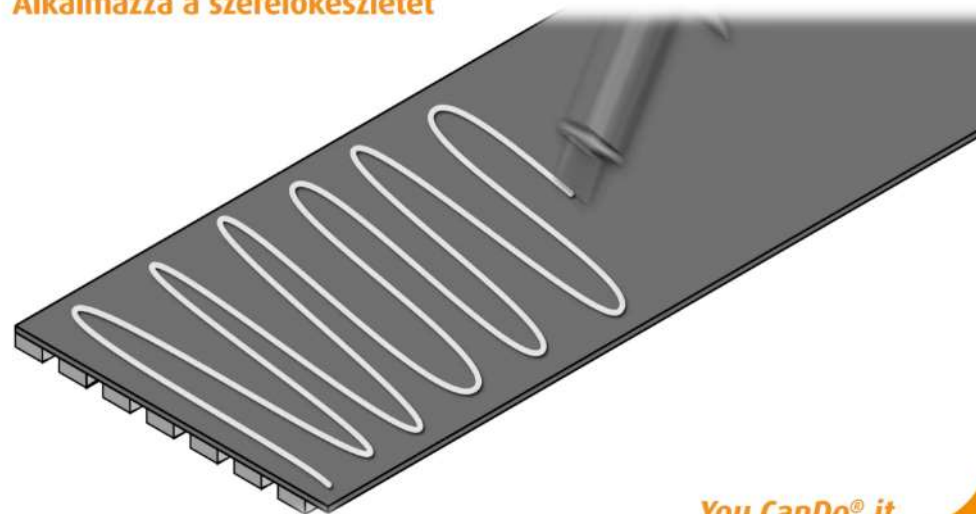

You CanDo® it

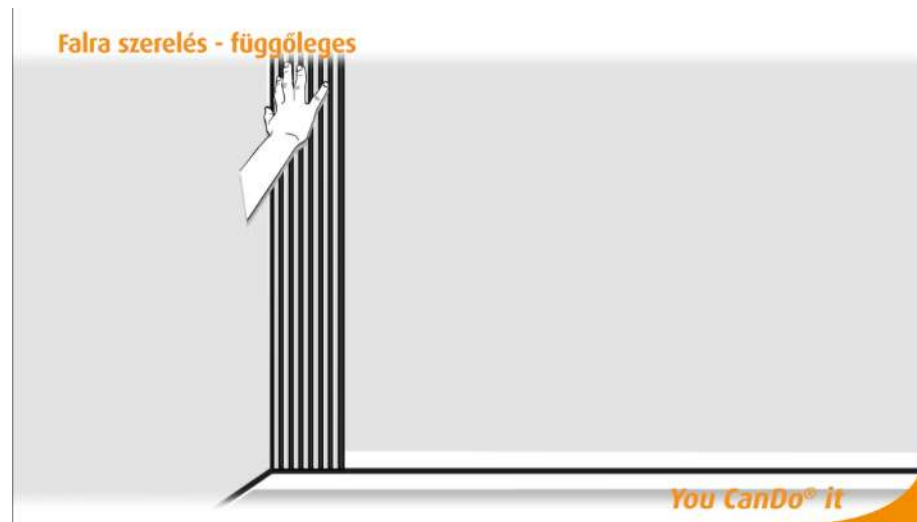
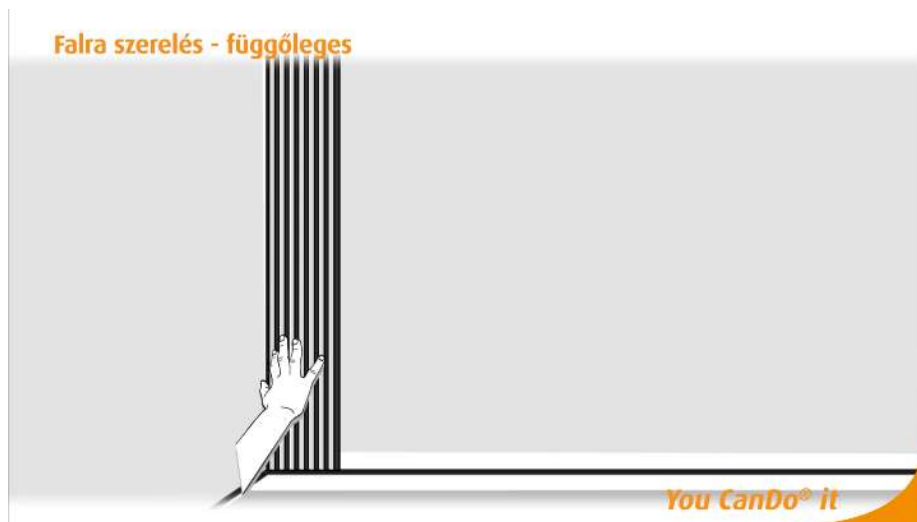

Erősen szorítsa a falhoz több helyen is a beragasztózott falpaneleket!

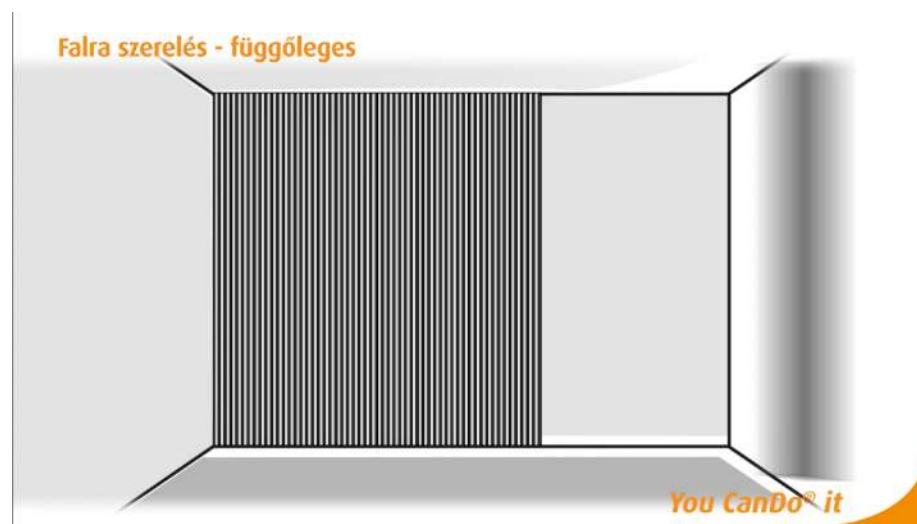
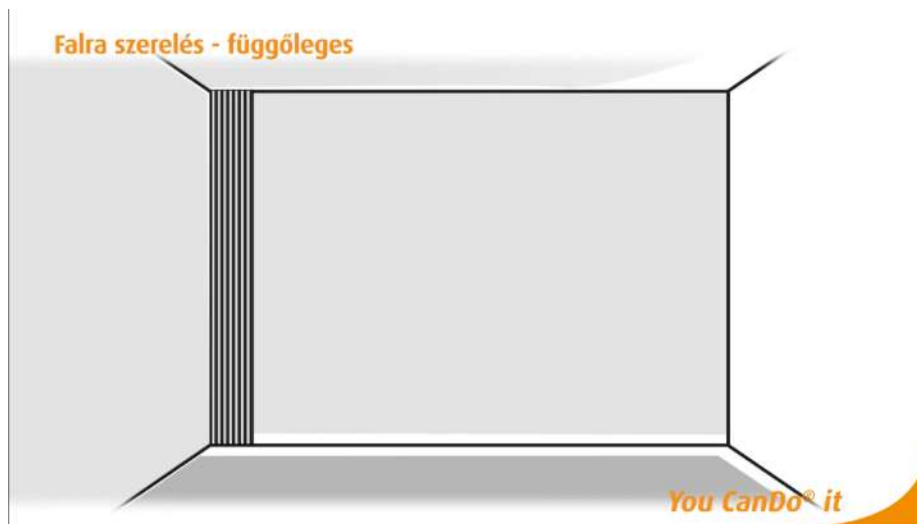

Falra szerelés - Panelozás

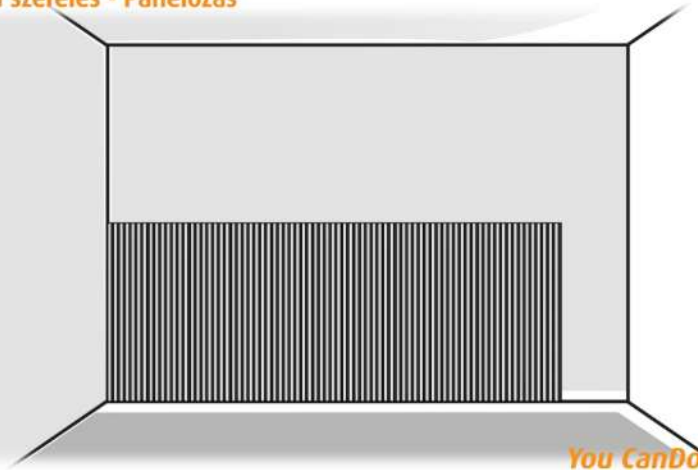

You CanDo® it

Befejezés végprofilal

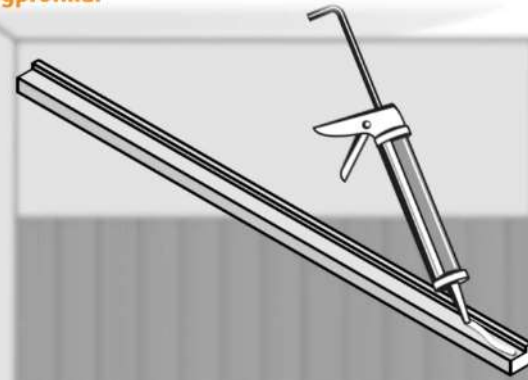

You CanDo® it

Befejezés végprofilal

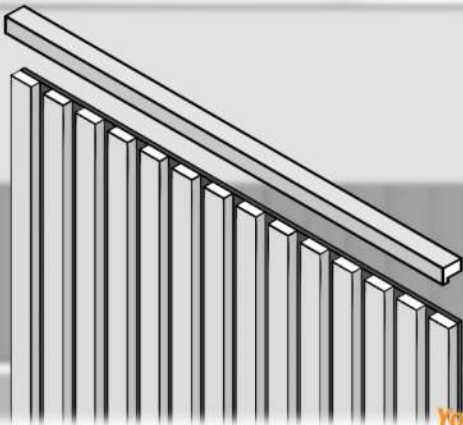

You CanDo® it

Befejezés végprofilal

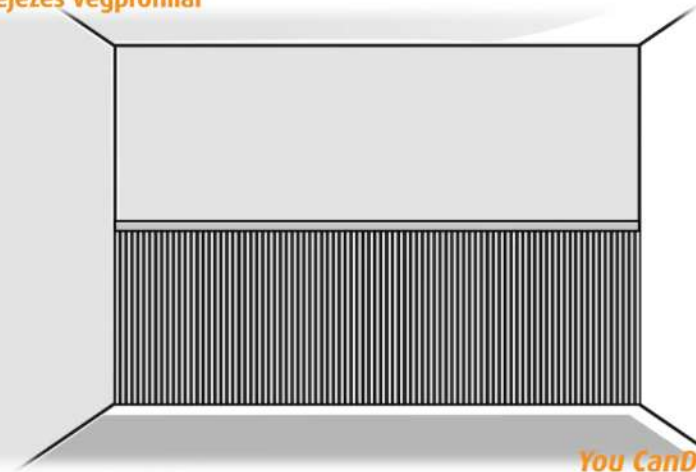

You CanDo® it

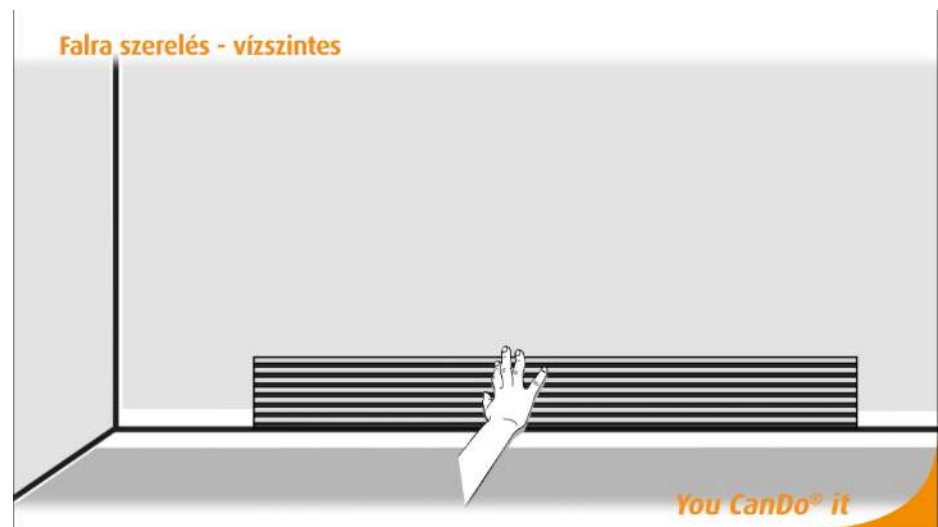
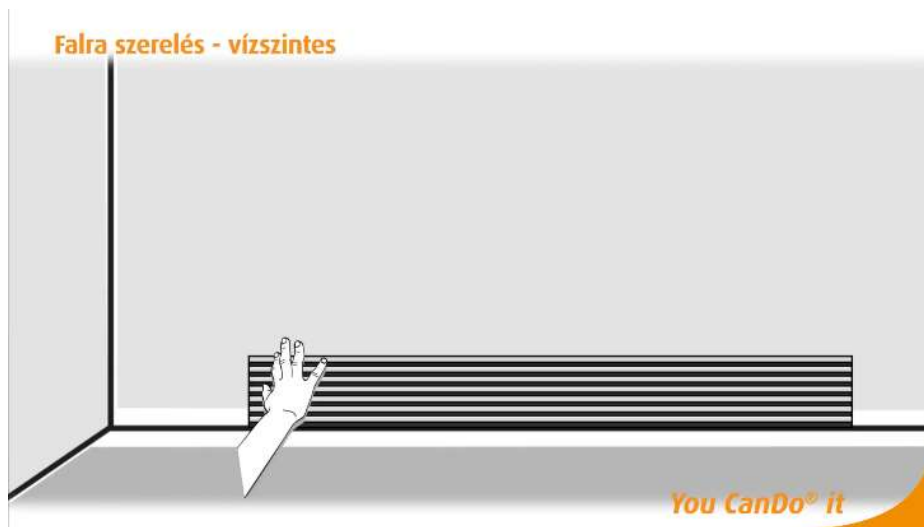

Erősen szorítsa a falhoz több helyen is a beragasztzott falpaneleket!

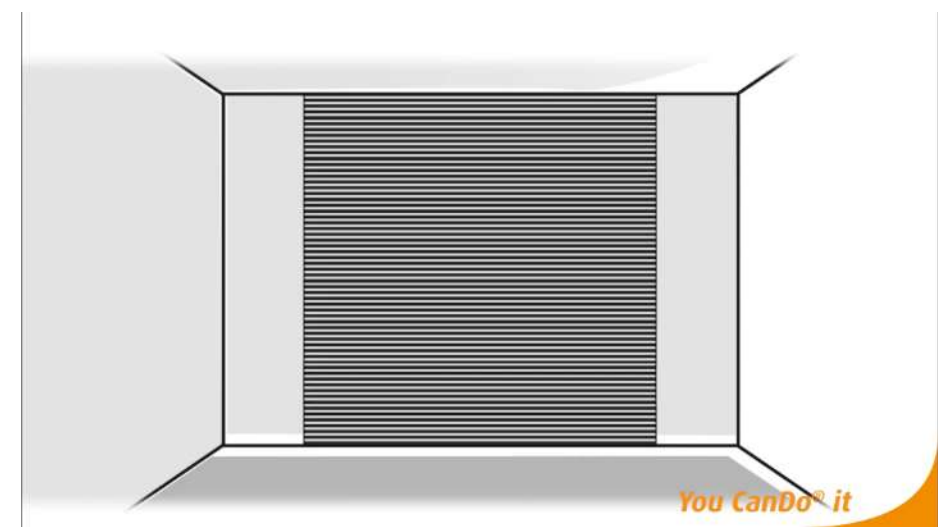
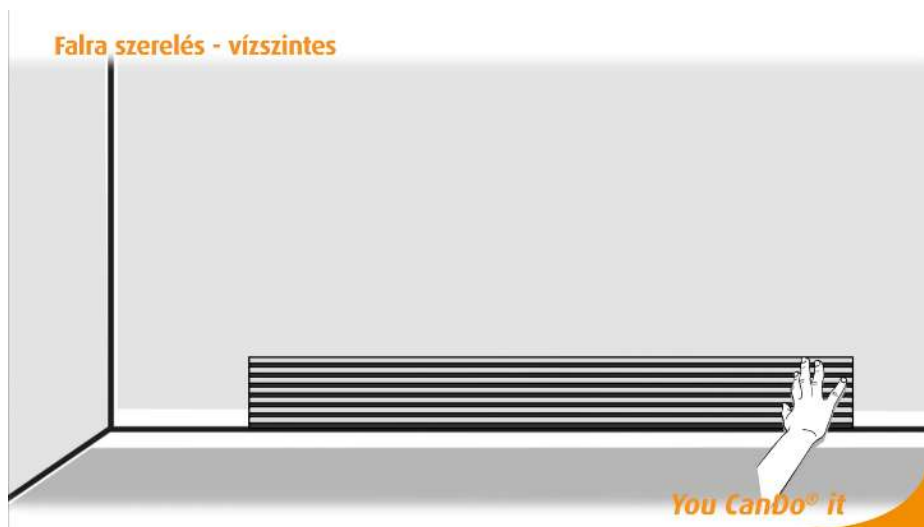

Befejezés végprofilokkal

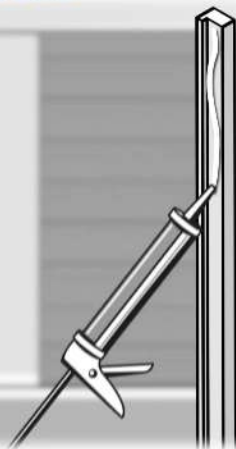

You CanDo® it

Befejezés végprofilokkal

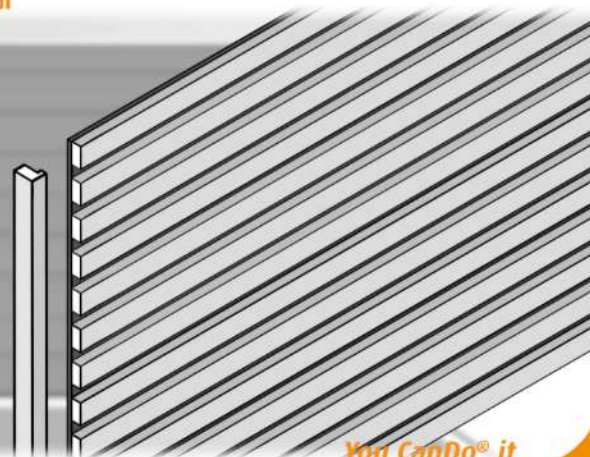

You CanDo® it

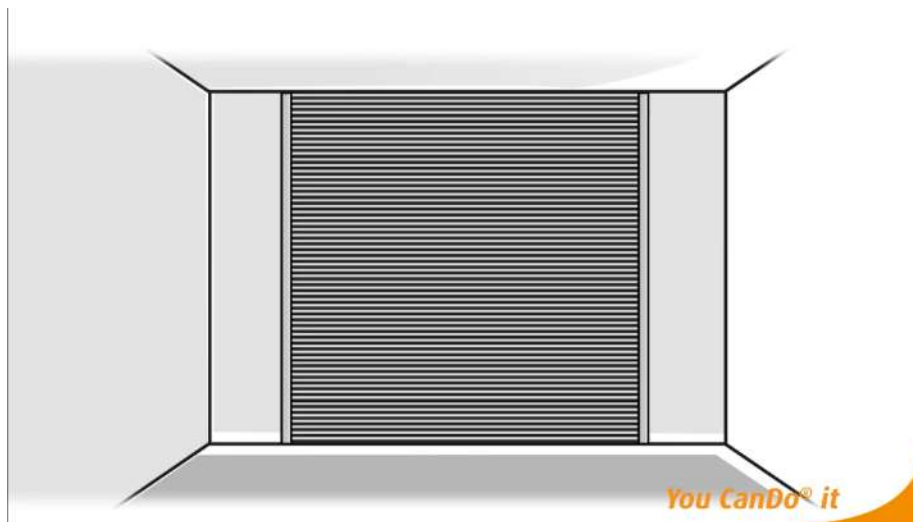

You CanDo® it

Szerelés a mennyezetre

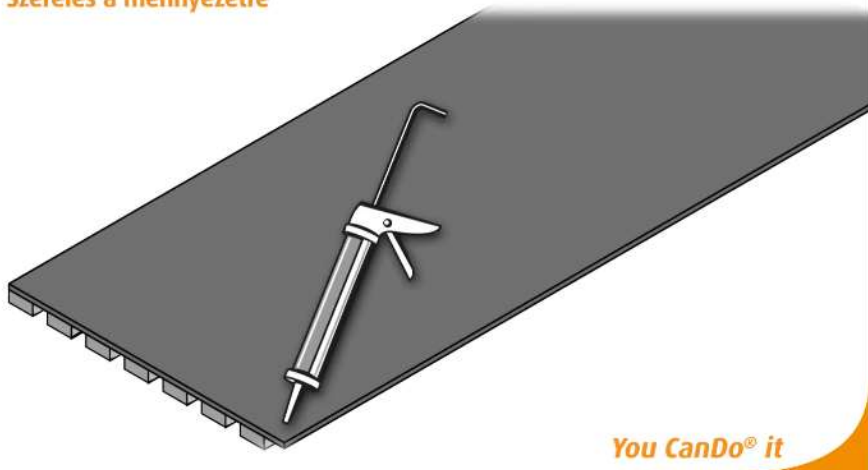

You CanDo® it

Szerelés a mennyezetre

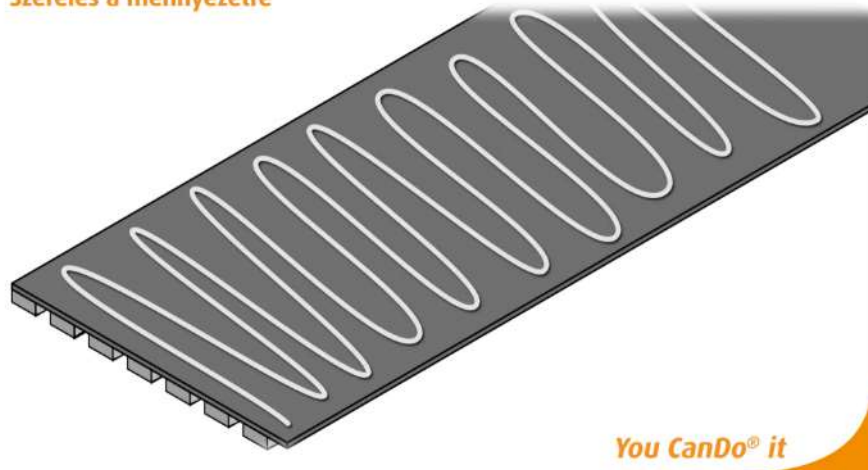

You CanDo® it

Szerelés a mennyezetre

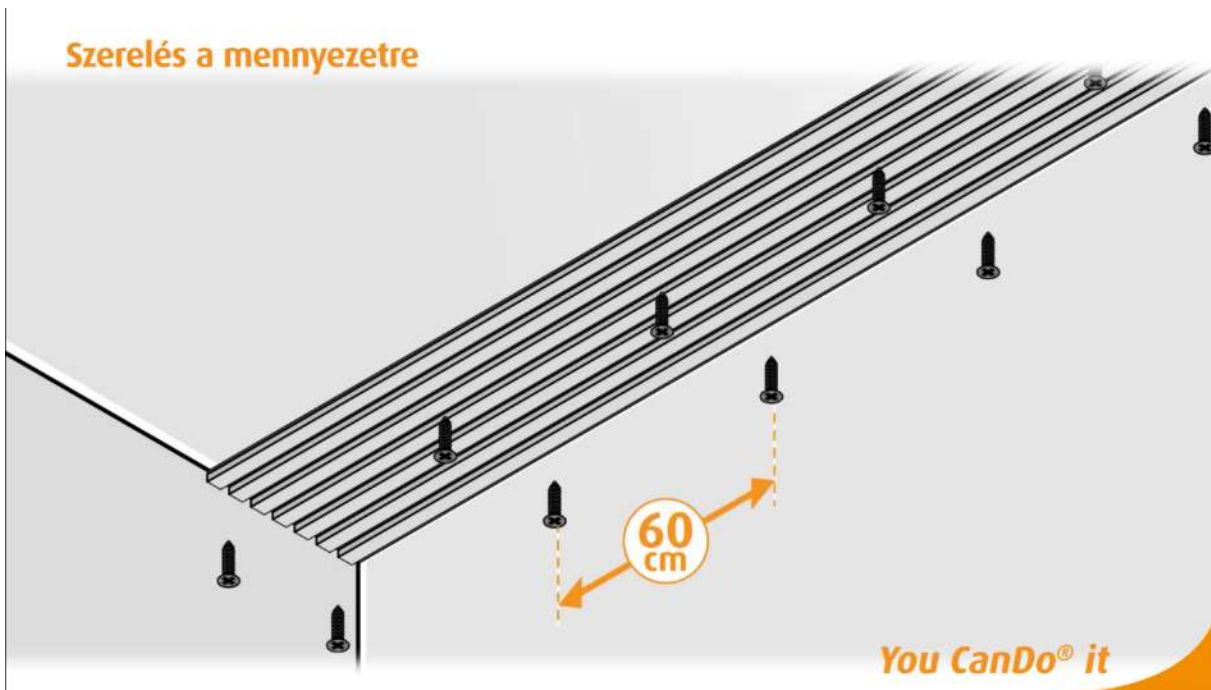

You CanDo® it